

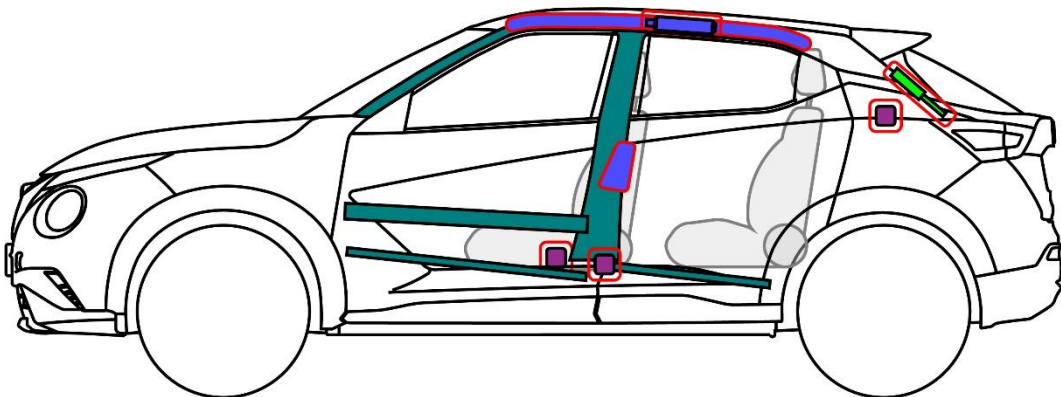

NISSAN

JUKE

Typ: F16, 5-Türer SUV
(2019 -)

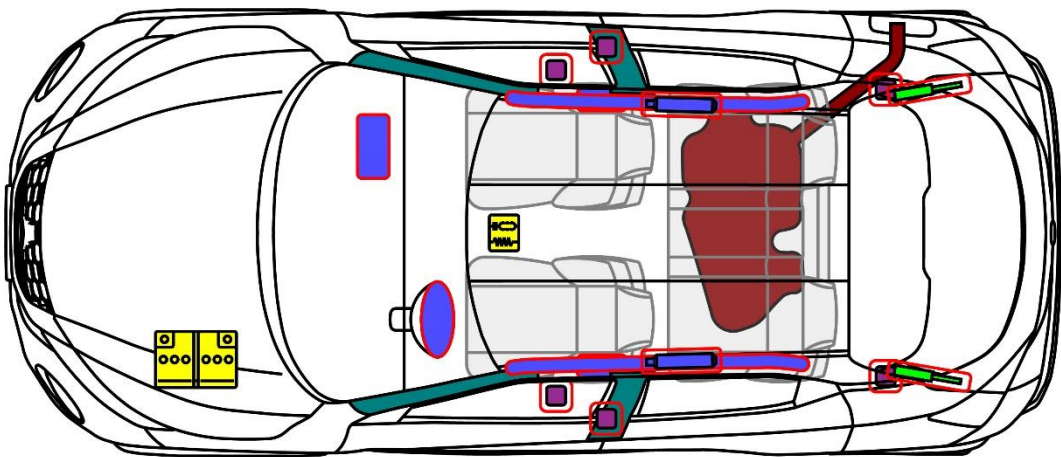

	Airbag		Gasgenerator		Gurtstraffer		SRS Steuergerät		Aktives Fußgänger- schutzsystem
	Automatisches Überroll- Schutzsystem		Gasdruckdämpfer / vorgespannte Feder		Karosserie- Verstärkung		Bereich Bedarf besonderer Aufmerksamkeit		
	Niedervolt Batterie		Niedervolt Kondensator		Triebstofftank		Gastank		Sicherheitsventil
	Hochspannungs- batterie		Hochspannungs- kabel		Hochvolt-Trennstelle		Sicherung zur Abschaltung der Hochspannung		Hochspannungs- kondensator
	Benzin- Ethanol- Kraftstofftank								

1. Identifizierung/Erkennung

Modellbezeichnung



Tankdeckel



Marke



2. Immobilisieren/Stabilisieren/Anheben

Fahrzeug immobilisieren:

1. Räder verkeilen
2. Gangwahlhebel in Position parken (P) bringen
3. Feststellbremse betätigen
4. Start / Stopp-Taste drücken



Anhebe punkte

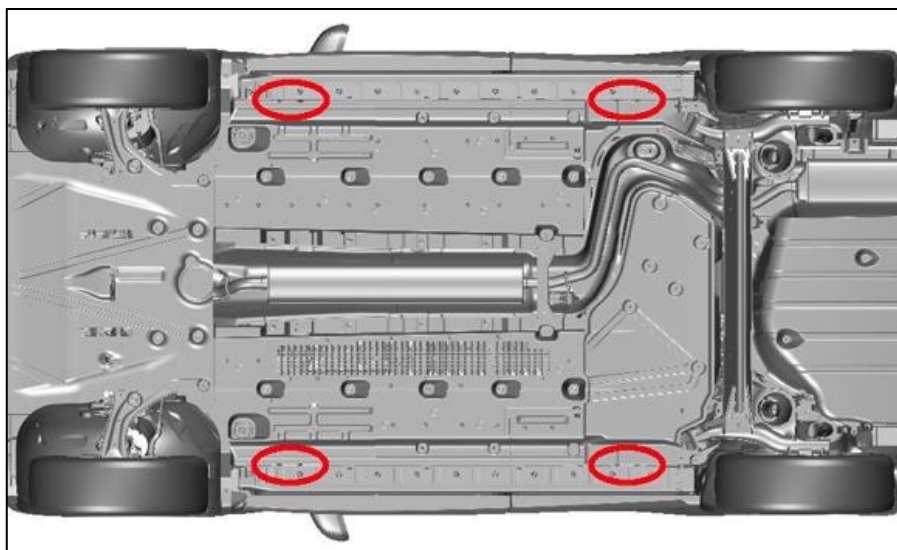

3. Direkte Gefahren ausschalten/Sicherheitsbestimmungen

Zugang zum Motorraum



12-V-Batterie abklemmen

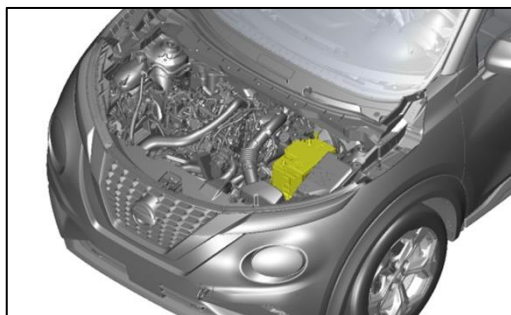
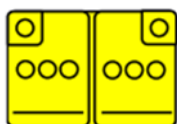

1. Zündung ausschalten
2. Minuspol (-) abklemmen
3. Pluspol (+) abklemmen

4. Zugang zu den Insassen

Hochfester Stahl in der Karosserie

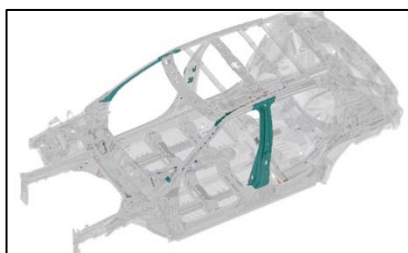

Hochfester Stahl in der Tür

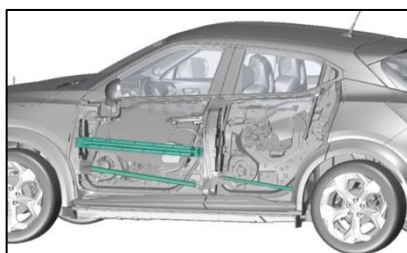

Lenksäulenverstellung



Sitzverstellung











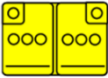

Glasarten:

- A. Verbundsicherheitsglas.
- B. Einscheibensicherheitsglas.



5. Gespeicherte Energie/Flüssigkeiten/Gase/Feststoffe

	12V	 
	R-1234yf 450 ±25 g	   
	46 L	 

6. Im Brandfall



WASSER VERWENDEN



GASDRUCKDÄMPFER, GEFAHR DES RAKETENEFFEKTS

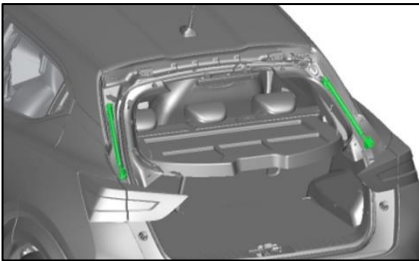

8. Abschleppen/Transport/Lagerung

Lagerung Abschlepphaken

Position vorderer Abschlepphaken







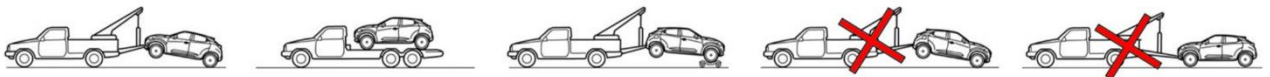



Position hinterer Abschlepphaken



Hinweise zum Abschleppen:



10. Erläuterung der verwendeten Piktogramme

	Gefahr		Entzündbar
	Warnung; niedrige Temperatur		Gesundheitsschädlich
	Gas für Klimaanlage		Explosiv
	Fahrzeug mit Treibstoff der Kl.asse 2		Korrosiv
	Motorhaube		Mit Wasser löschen